

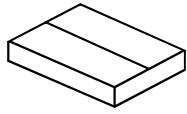

30 min

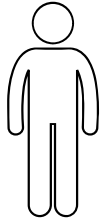

x1



x1



A x1

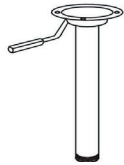

B x1

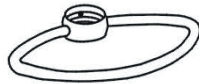

C x1



D x1



E x1

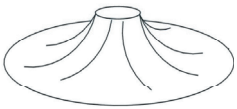

F x1

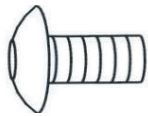

G x2
(M6x25mm)

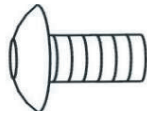

H x2
(M6x20mm)



I x1



J x1

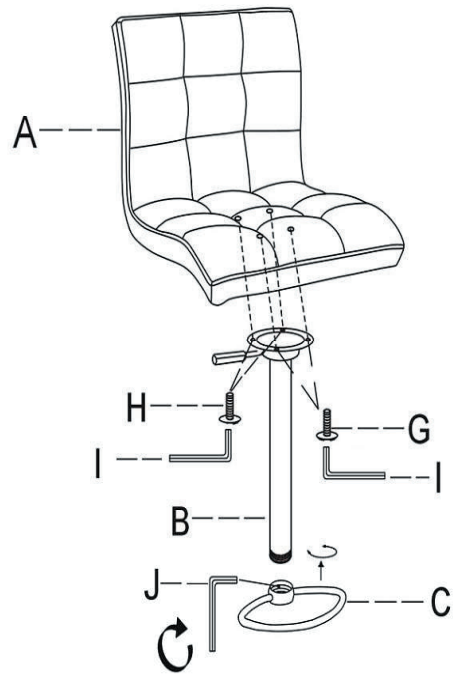

Quitar la protección de plastic antes de montar	Remove plastic cap before assembling.
---	---------------------------------------

