

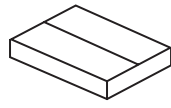

20 min

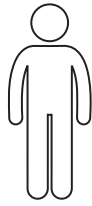

x2



x2

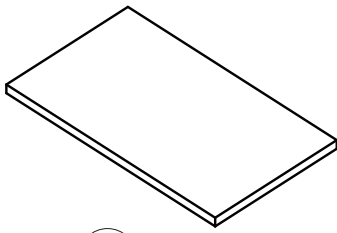

① x1

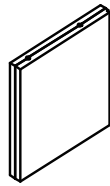

② x1

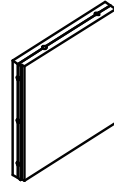

③ x1

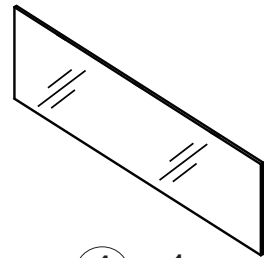

④ x1

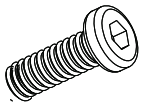

Ax9 (M8x25mm)

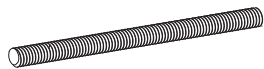

Bx4 (M8x360mm)



Cx3 (Ø10x40mm)

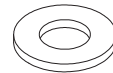

Dx12 (M8x16mm)



Ex10 (M8)

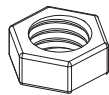

Fx7 (M8x5mm)

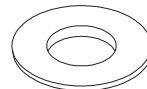

plastic
Gx6 (M8x24mm)

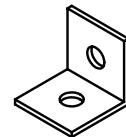

Hx6 (40x40mm)

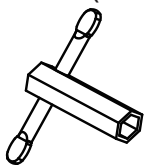

Ix1 (M8)

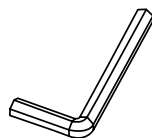

Jx1



Kx4 (M8x20mm)

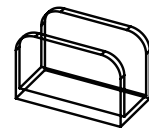

Lx2 (38x28x16mm)

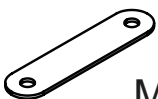

Mx1



Ø3.5X20 Nx2

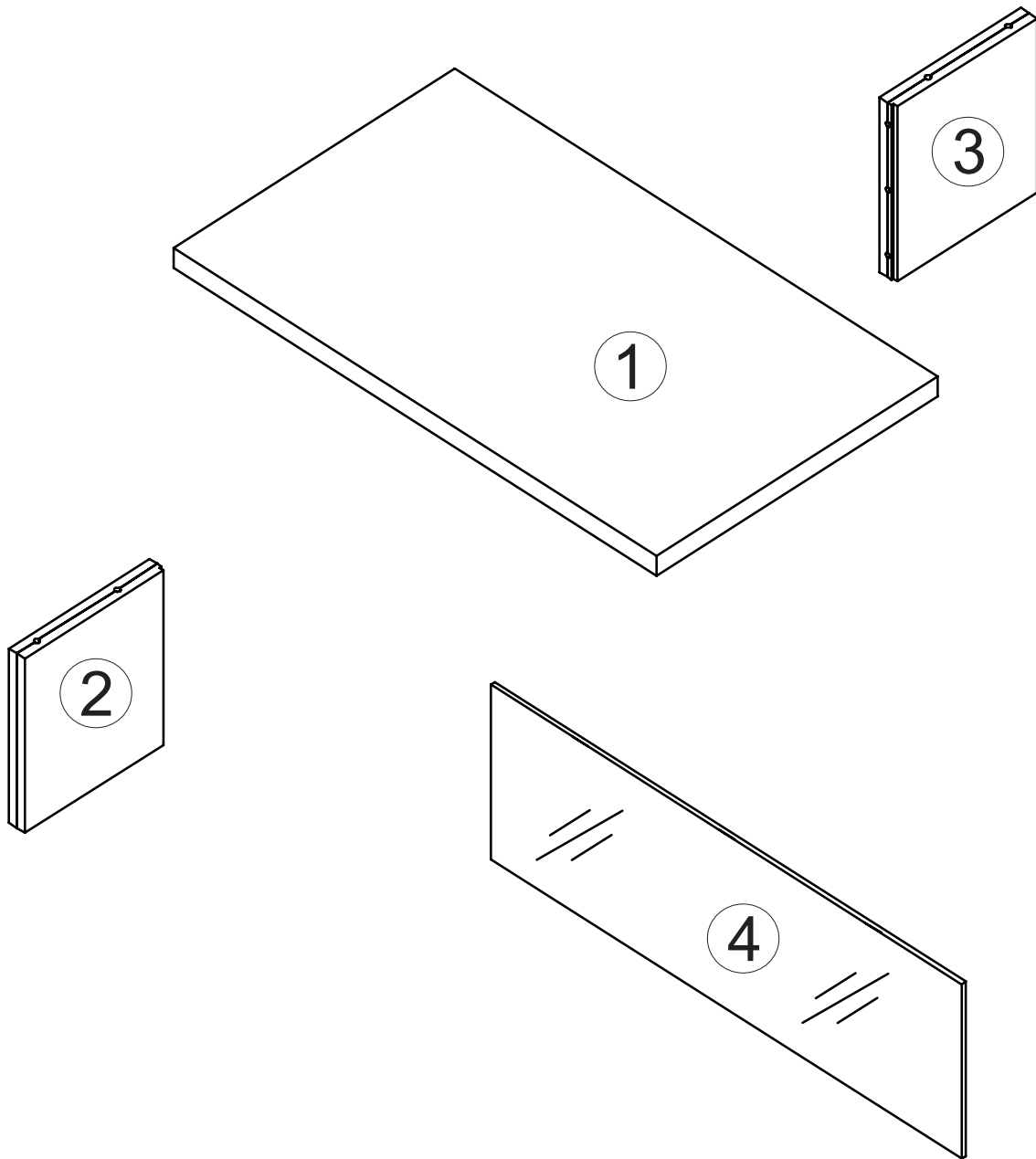

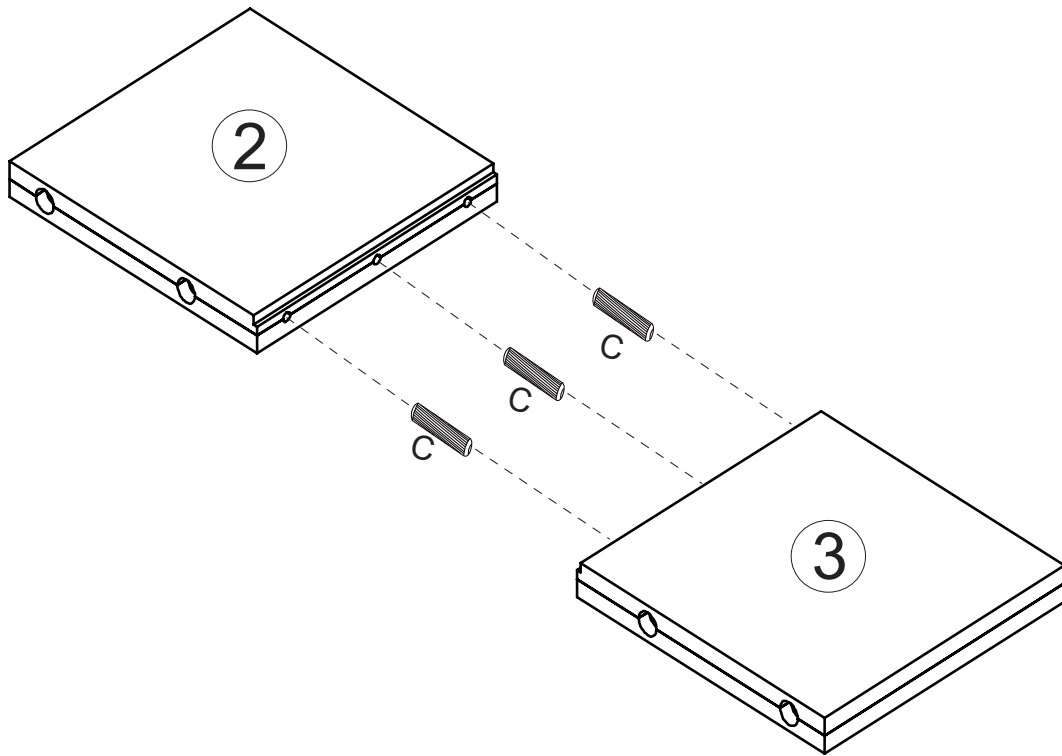
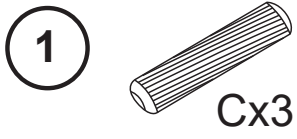

2

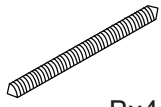

Bx4



Kx4

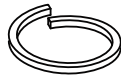

Ex4

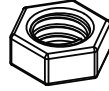

Fx4

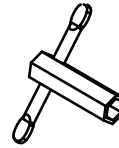

Ix1



Mx2

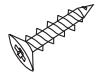

Nx4

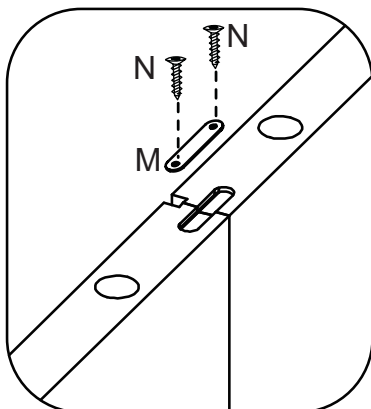
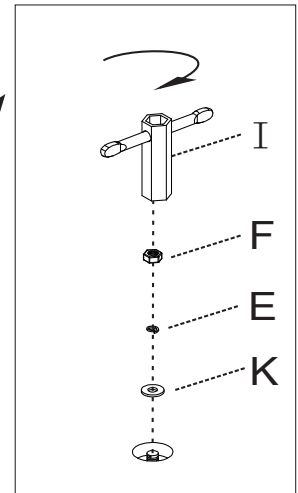
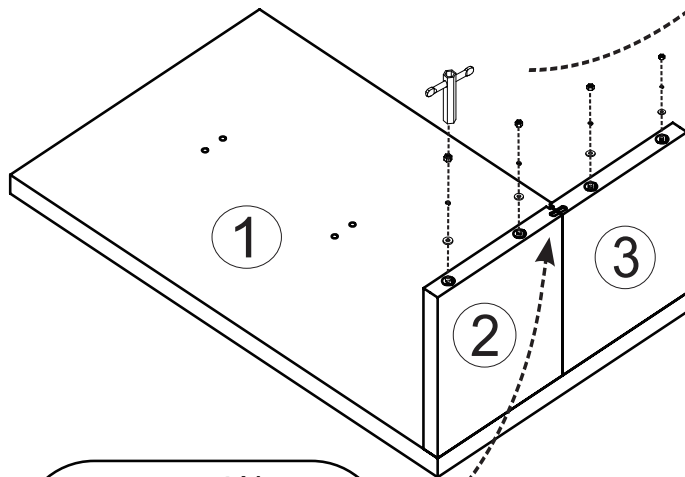
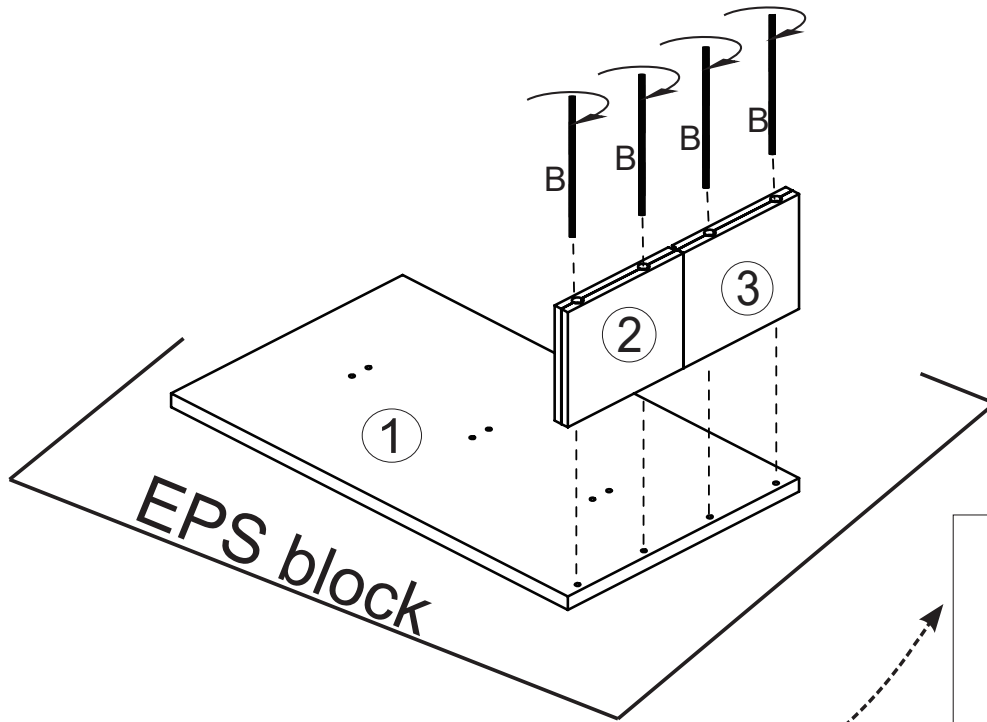

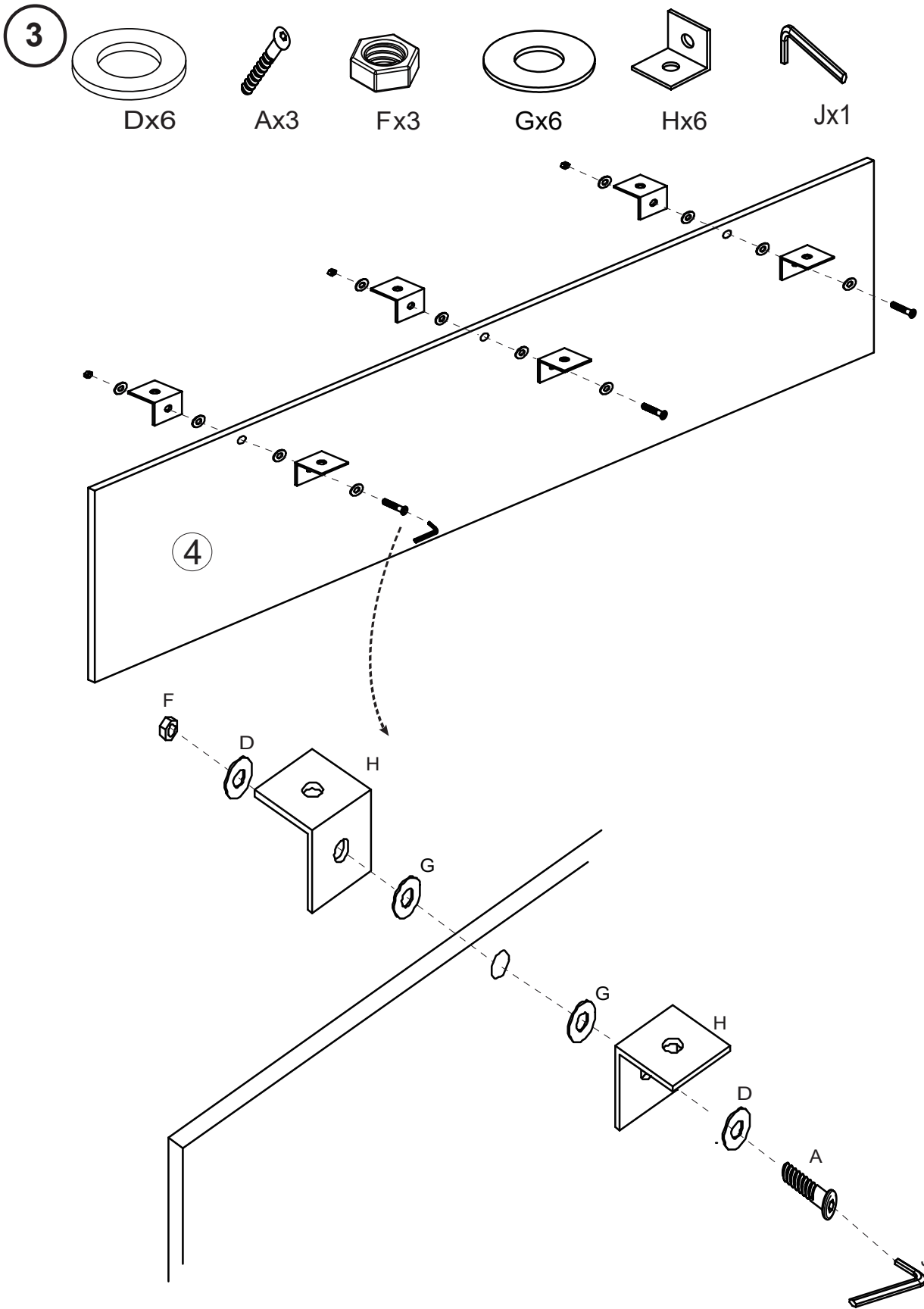

3



Ax6

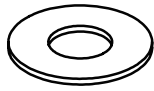

Dx6

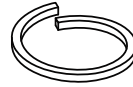

Ex6



Jx1

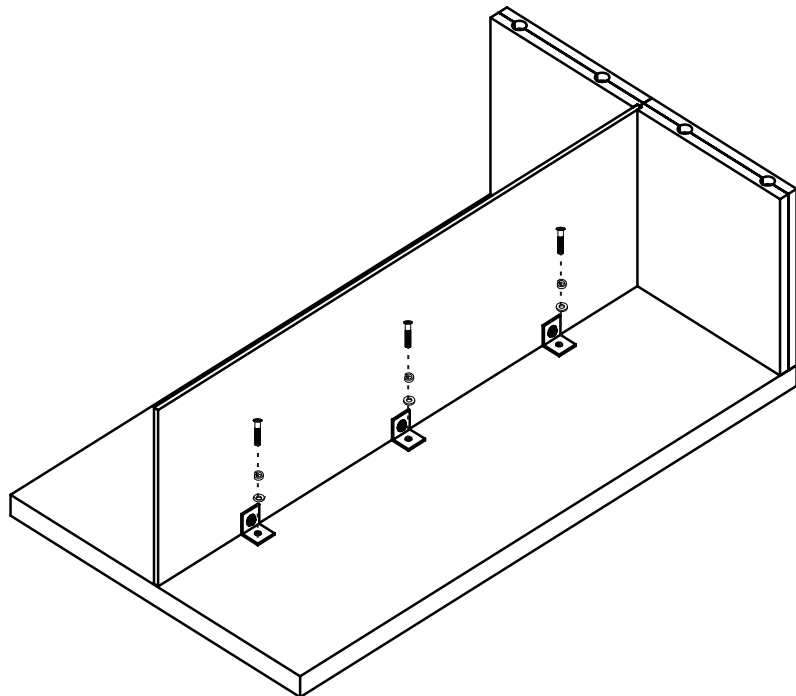
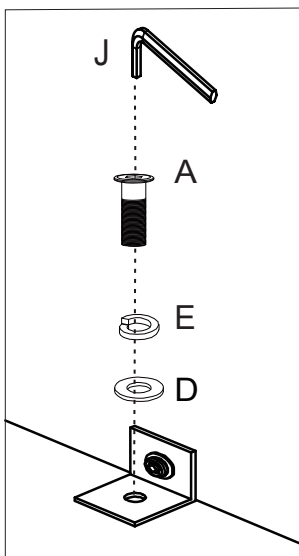
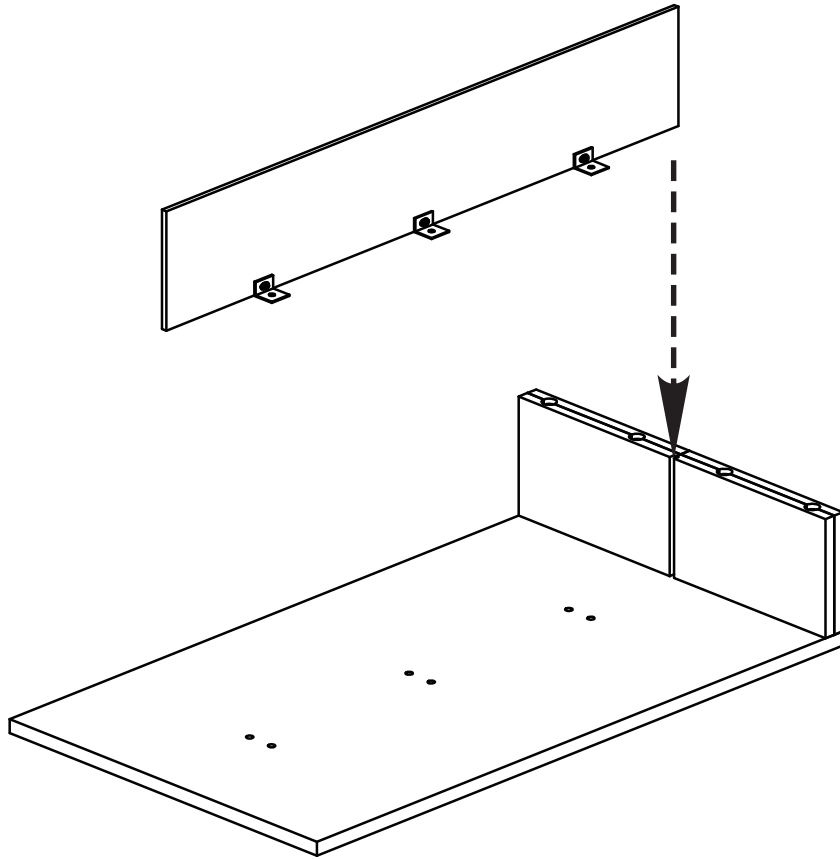

4

Lx2

