

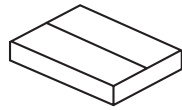

20 min

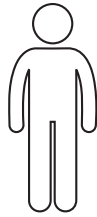

x2



x2

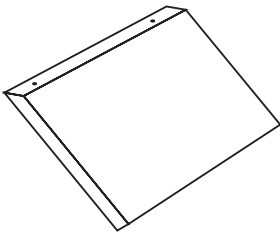

① x1

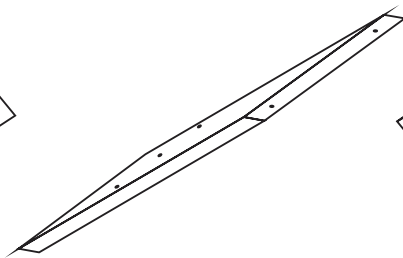

② x1

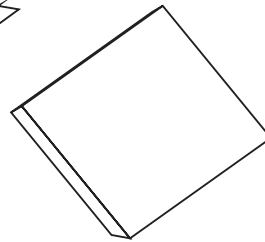

③ x1

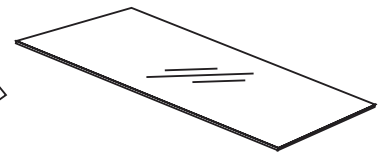

④ x1

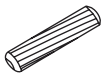

Ax2 (Ø10x40mm)

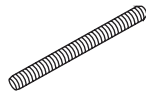

Bx4 (M8x90mm)



Cx4 (30x15mm)

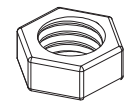

Dx4 (M8x5mm)

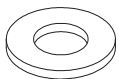

Ex4 (M8x16mm)



Fx4 (M8)

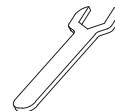

Gx1



Hx4

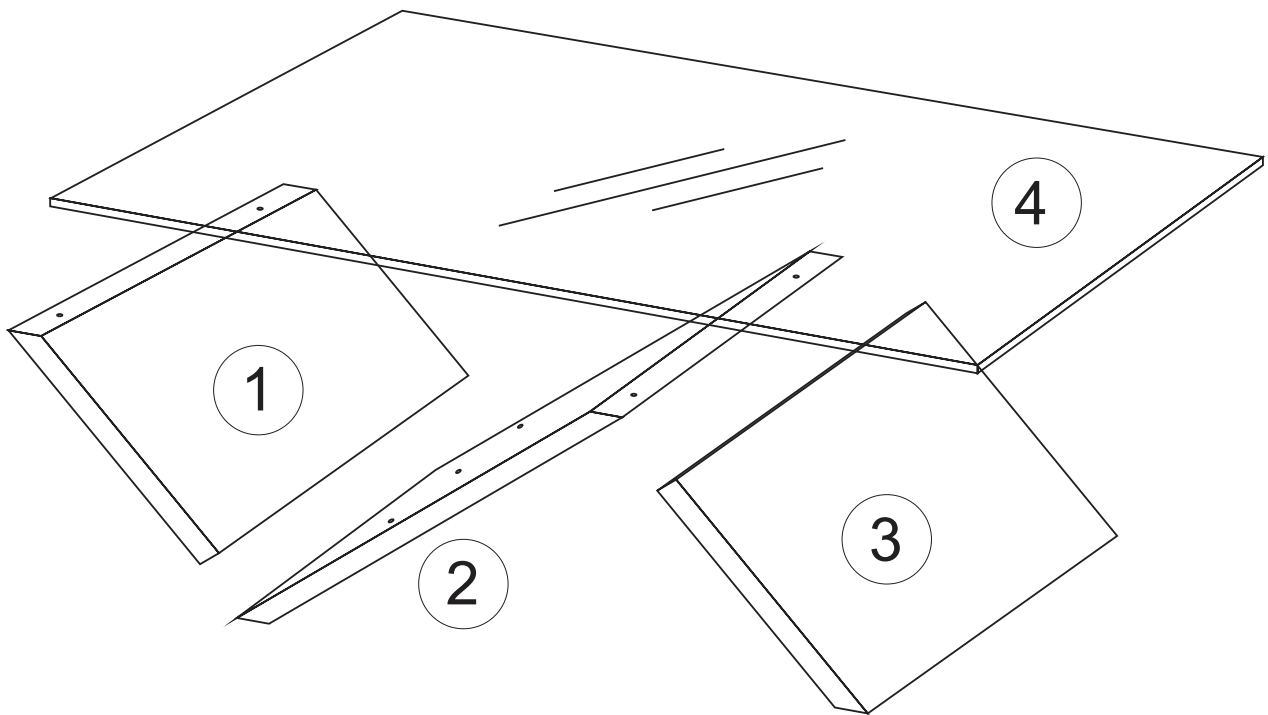

- ① C  x4 F  x4 E  x4 D  x4 G  x1

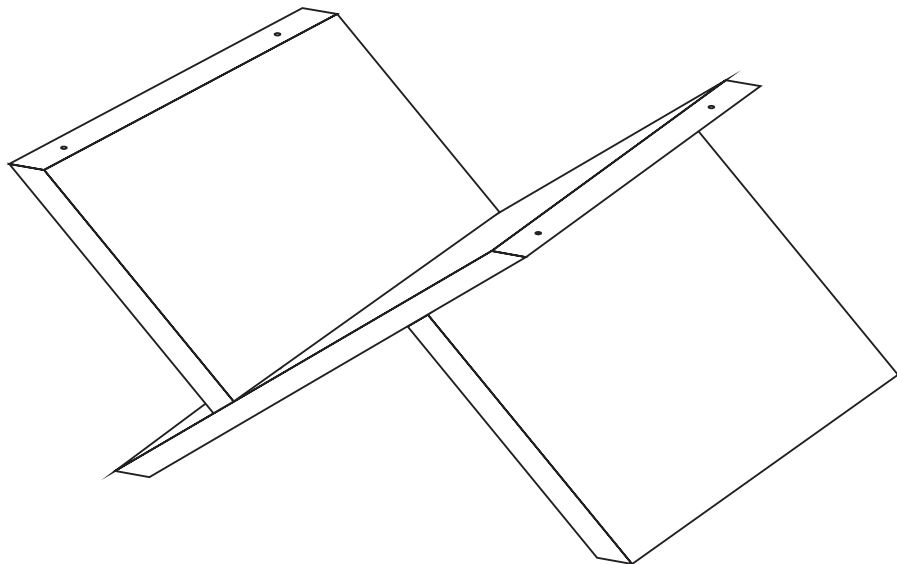
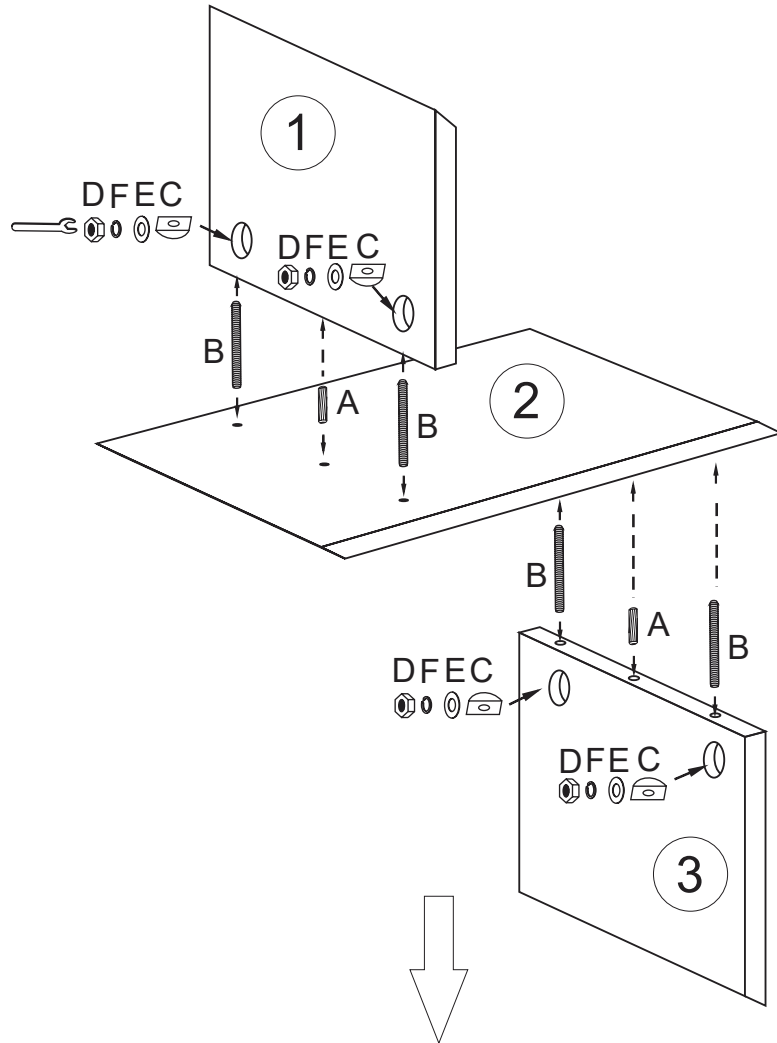

2 H  x4

